

FRONT DOOR COMPONENTS

750DM-01

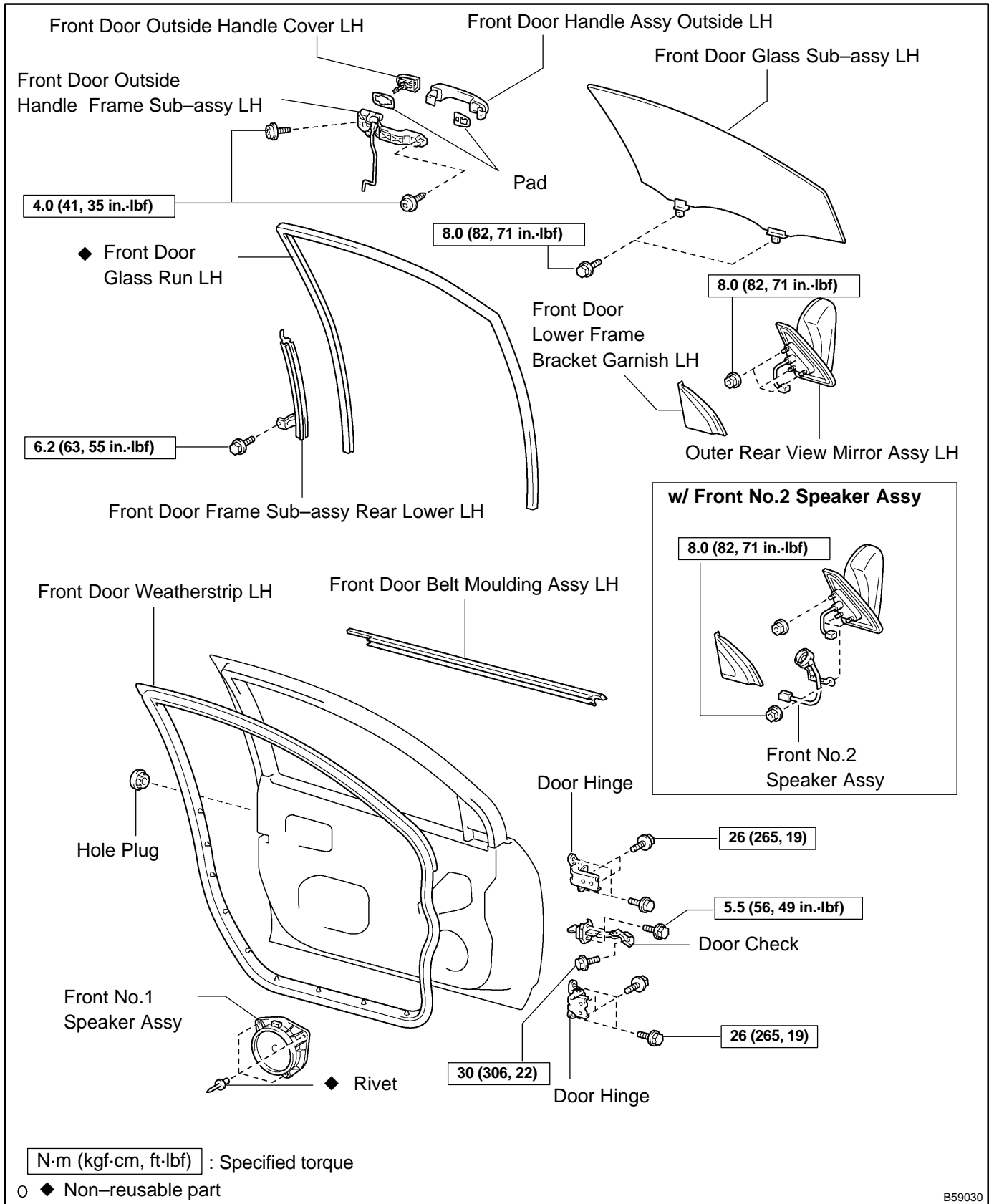

B59030

w/ Power Door Lock

★ 5.0 (51, 44 in.-lbf)

Front Door Lock Assy LH

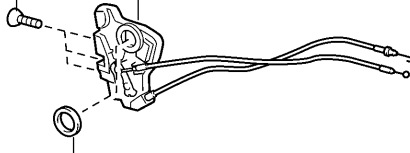

◆ Door Lock Wire Harness Packing

w/ Power Window

8.0 (82, 71 in.-lbf)

5.4 (55, 48 in.-lbf)

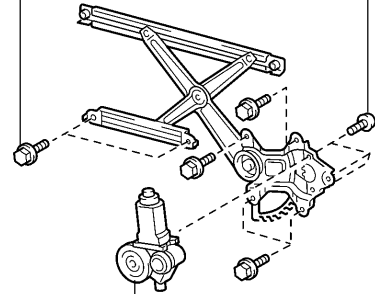

Power Window Regulator Motor Assy LH

w/o Power Door Lock

★ 5.0 (51, 44 in.-lbf)

Front Door Lock Assy LH

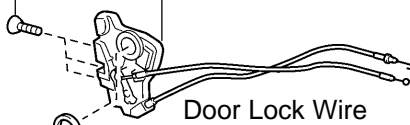

Door Lock Wire
◆ Harness Packing

Front Door Inside
Panel Plate LH

Front Door Reinforcement

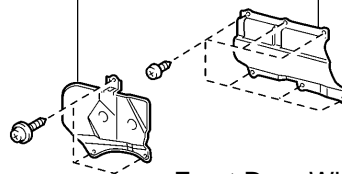

Front Door Window Regulator Sub-assy LH

◆ Front Door Service
Hole Cover LH

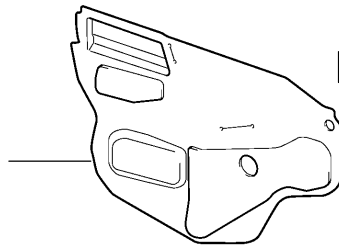

8.0 (82, 71 in.-lbf)

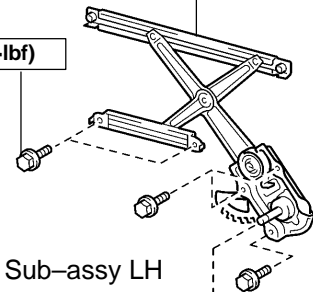

Front Door Inside Handle Sub-assy LH



Front Door Trim Bracket

Front Door Pull Handle LH

w/ Power Window

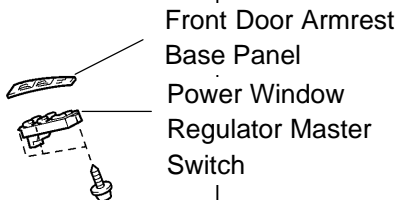

Front Door Armrest
Base Panel
Power Window
Regulator Master
Switch

Front Armrest Base
Panel Upper LH

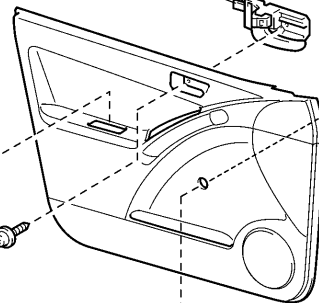

Front Door Trim
Board Sub-assy LH

Plate
Snap Ring

Front Door Window Regulator Handle Assy

N·m (kgf·cm, ft·lbf) : Specified torque

◆ Non-reusable part

○ ★ Precoated Part

B59031